

ADUR AMATEUR RADIO CLUB

HAM EXPO '96



SOUVENIR



ADUR

8<sup>TH</sup> SEPT '96



**ADUR AMATEUR RADIO CLUB****MUKALETHU MATOM, ADUR 691 523****PHONE: (0473) 422358, 424233****MEMBERS**

PRABHAKARAN  
 MADHUSUDANAN .M.  
 PARAMESWARAN PILLAI  
 V.VIJAYA PRADEEP,  
 VIMAL,  
 OOMMEN GEORGE,  
 P.K. ASHRAF, Mundakkayam.  
 PRAKASH.V.K, Ezhukone  
 RAMESH KUMAR, Pattazhy  
 BINOY JOHN, Kadampanadu,  
 SAJLS, Keralapuram  
 SURESH.S.R., Avaneeswaram  
 MANOJ.T, Adur  
 ANIL KUMAR, Adur  
 ASHRAF KHAN, Pathanamthitta  
 SHAJAHAN, Pthanamthitta  
 RAJESH. R., Mannady  
 ANIL KUMAR, Parakode

VU2 PBT  
 VU2 MBF  
 VU2 PWN  
 VU3 PRA  
 VU3 VML  
 VU2 OOE

ANIL KUMAR, Kayamkulam  
 EBY .P. KURIAN, Kayamkulam  
 MOHAN BABU, Punalur  
 RAJAN BABU, Punalur  
 GEETHA KUMARY, Kottayam  
 BIJU GEORGE, Kadampanadu  
 ANISH.P.R, Sasthamkotta  
 P.VENUGOPAL, Edayarannula  
 JOHN PHILIP, Adur  
 SREEKANTH, Kottarakara  
 L.VJAYAPRAKASH, Kottayam  
 SIJLM, Adur.  
 M.D.THOMAS, Adur  
 BIBIL PUNNOOSE, Adur  
 LAL SEBASTAIN, Ranni  
 PRAVEEN.R, Adur  
 SALEEM YOOSUF, Pandalam  
 MUSTHAFA RAWTHER, Kottarakara





# ADUR AMATEUR RADIO CLUB

## SOUVENIR

FOR PRIVATE CIRCULATION ONLY

### Contents

**H**

HAM RADIO - KING OF HOBBIES ..... 7  
P.Thajudeen, VU3 TJN

**A**

SHORT WAVE LISTENING ..... 9  
L.V.Sharma, VU2 LV

**M**

MORSE CODE ..... 11  
N.G Koshy VU2NNB

HAM ANECDOTE ..... 15

IRF 830 LINEAR ..... 15  
P.M Yaseen, VU3PMY

**E**

SOME VFO DESIGN STANDARDS ..... 17  
Devan, VU2 RMZ

**X**

POWER SUPPLY FOR HAND HELD RIGS ..... 17  
G. Pradeep Kumar

**P**

TWO METRE BEAM ANTENNA ..... 19  
Dr.K.Raju, VU2 GOK

**O**

FREQUENCY COUNTER ..... 19  
Dr:N.Vasudevan Nair VU2 VDN

7 MHz TRANSCEIVER ..... 23  
P.Ramaswamy, VU2 PRI

7 MHz VFO WITH MEMORY ..... 29  
Ajaya kumar.B.&Praveen.R.

**'96**

HOMEBREW RECEIVER FOR 40 METRE ..... 31  
Devan VU2RMZ



# HAM RADIO CORRESPONDENCE COURSE

**KERALA AMATEUR RADIO LEAGUE**, the oldest ham association in Kerala, was the first to start correspondence course in amateur radio. Several hams like VU2JKR, VU2DOC, VU2MTW, VU2NGS, VU2ELJ, VU2PWN, VU2MAF became hams by joining this course. The course covers the syllabus for ASOC examination and includes model question papers with answers and all information about the examination. Contact classes are held regularly at different centres for giving coaching and practical training in Morse. Members of the course will receive our periodical **INDIAN HAM** free for one year.

For details write to:

**KERALA AMATEUR RADIO LEAGUE**  
**P.O. BOX NO: 335, KOLLAM**  
**691 001, KERALA.**

---

## LITTLE MISER'S MINI TX FOR 7 MHZ

MODEL NO: ONC 7393 /L7

**QUILON AMATEUR RADIO LEAGUE** is happy to present the new generation low power, low cost, transmitter "LITTLE MISER'S MINI TX". Based on the famous VWN circuit and modified by VU2 NDA Om Dasan it satisfies the need of the beginner who wants to come on the air with minimum investment. The operating frequency is 7.0 to 7.1 Mhz on A1A and A3E modes. The rig operates on 12 volt DC supply. Frequency can be shifted by 100 KHz so that AM can be heard without any difficulty. fitted with power meter which indicates whether power is going out. Controls include On/Off switch, VFO shift control, VFO tuning, AM/CW switch, Key jack, Mike/PTT socket, Mike gain control, Power meter. For details write to:

**QUILON AMATEUR RADIO LEAGUE,**  
**SHRUSHTI, BEACH ROAD, KOLLAM, PIN-691 001.**



**ADUR AMATEUR RADIO CLUB**  
**MUKALITHU MATOM**  
**ADUR, KERALA - 6 91 523.**



: 0473 - 422358

OFFICE BEARERS

Patron

L.V.SHARMA VU2 LV

PRESIDENT

DR. K. RAJU VU2 GOK

VICE PRESIDENTS

BENCY ZACHARIAH VU2 GVX  
 N.G. KOSHY VU2 NNB

SECRETARY

P. THAJUDEEN VU3 TJN

JOINT SECRETARIES

AJAYA KUMAR.B.  
 VICHITRA KUMAR.P.R.

**ADUR AMATEUR RADIO CLUB**

**SOUVENIR '96**

Editorial Team

Patron

L.V.SHARMA VU2 LV

CHIEF EDITOR

Dr.K.RAJU VU2 GOK

STAFF EDITORS

SALEEM YOOSUF  
 P.THAJUDEEN VU3 TJN  
 VICHITRA KUMAR.P.R.  
 AJAYAKUMAR.B.  
 N.G.KOSHY VU2 NNE  
 BENCY ZACHARIAH VU2 GVX  
 VIJAYA PRADEEP VU2 PRA

LAYOUT ASSISTANT

SREELAL.K.B. PANDALAM

TYPE SETTING

ALTECH COMPUTERS, PANDALAM

LAYOUT & ILLUSTRATIONS

SALEEM YOOSUF

PRINTING

National Offset, Thiruvalla.

## About ourselves

The Adur Amateur Radio Club was formed in 1993 mainly due to the earnestness of N.G.Koshy VU2NNB when he was still an SWL. The club started functioning with just ten members and Dr. K.Raju, VU2GOK was elected as the president and Koshy was the secretary. Within a short span of three years, the membership has grown to fifty and the club has made its presence felt by various activities. With a view to promoting ham radio, the club has always helped SWL's to prepare for the examination by conducting classes in theory and Morse code and supplying materials to them. The club has also involved itself in many activities like FoxHunt, Field days, demonstrations, workshop, contact classes etc. Two field days were conducted- one at Thenmala and one at Perunthenaruvi. Two day contact class was held for SWL's ASOC examination was conducted in January and out of 33 SWL's 31 passed. The club associated with KARL in conducting the first FOXHUNT and the winner was Om Bency and Pradeep, both members of our club. A demonstration of ham radio was held at district science fair at Kulakkada High School. With a view to create awareness among the public about ham radio, encourage SWL's to become hams, render all help needed by them and cater to the needs of licensed hams we are conducting the HAM EXPO 96. It is too early to say how far our efforts have been successful but we are sure that HAM EXPO will have its impact and encourage many to take to this hobby. We will be continuing the good work we have been doing by starting classes immediately after this programme. We also propose to conduct field days, workshops, demonstrations etc. during the coming months.

We deeply acknowledge our thanks to our members who by unselfish service have helped to the success of this venture. We also thank our advertisers with out whose help this Souvenir would not have come out.

L.V.Sharma, VU2LV  
 Convener.



# We shall pray to God for your individual and Social welfare

by

ECUMENICAL PRAYER CENTRE,  
MANGAL DWEED,  
ST.MARY'S ROAD,  
Adur.

## **Best wishes to Ham Expo'96**

## **TV, V C R, RADIO, SERVICING**

## **DEALERS OF ALL KINDS OF ELECTRONICS SPARES**

# Zigma Electronics

Panchayath Shopping Complex,  
Market Junction,  
Kottarakara.



## Amateur Radio King of Hobbies

Every morning I sit in my room and call CQ CQ CQ through microphone of my transmitter and within a few minutes I hear the voice of another operator replying to my call from a distant part of the globe in response to my CQ Call. I hear the person from the other side of the globe cordially wishing me a pleasant good morning and gives me my signal report, and immediately a lasting friendship is established between myself and the other whose name I have not heard and whom I have never seen and whose voice I am listening for the first time. We enter into a conversation and he becomes my lifelong friend. I may not even recognise him if I meet him in person but the friendship established through ham radio is so lasting and so intimate that he will do anything for me. There are thousands of ham in India alone and the number runs into lakhs in countries like Japan, USA Germany etc. All that you require for contacting hams the world over is a transmitter and a receiver and a good antenna. This is the only hobby which is subject to international and national rules & regulations, it requires a license from the Government It is also one of the cheapest of hobbies because after the initial investment the maintenance cost is negligible. By investing about Rs.500 you can start operating which may sound unbelievable to you. You can learn a lot about people in other countries, their customs, habits, daily life, art and their problems. There are many hams who are electronic engineers and students can discuss their problems in electronics and computer engineer with their counterparts in other places. This hobby is suitable not only for young people but also for retired people who find time hanging in their hands and also for handicapped people who cannot go outdoors. There are many hams who are blind There are hams from all walks of life like advocates, teachers, doctors, students engineers and a few minutes of conversation with them daily will relieve the stress and tension of daily life.

You will require a transmitter, a receiver and antenna to operate on the air. You can buy or assemble your own transmitter. Commercial transmitters are costly, hence many hams assemble their own transmitter. For receiver, you can use your own domestic radio, if it is sufficiently sensitive. But it should be able to receive short wave stations clearly. The antenna is critical and time spent on erecting a good antenna will be rewarding. When we talk the sound is picked up by the microphone and converted into radio waves by the transmitter and radiated into the outer space by the aerial. The reply from the other side is picked up by the aerial and reproduced by the receiver. Usually hams employ three types of transmission namely AM, FM, CW and SSB. Hams frequently use code words, code language and abbreviations in their communications. Some of these are very interesting to hear. A bike is a two wheeler, car is four wheeler and train multi wheeler. Old man (or OM) stands for any male operator and young Lady (YL) any female operator. XYL means a married woman. Getting married is referred to us

ADUR AMATEUR RADIO CLUB  
crystal controlling. GM is for good morning and CUL means "See you later". You can learn all these codes just by listening. Hams have to observe many rules when Rag chewing (talking) Politics, religion, financial matters are taboo. Hams are courteous and adjustable. They will patiently wait till the other party has finished talking before breaking into the conversation of a group. Each ham waits for his turn to come.

Ham radio is not a mere hobby. It is more than that. Under special circumstances, ham radio can be used for sending and receiving messages for others. During natural calamities like floods, earthquakes, cyclones etc. and unforeseen accidents, ham radio has been used for communication. For example during Lathur earthquake in Maharashtra, invasion of Kuwait by Iraq ham radio was the only means of communication with the outer world. Hams are also permitted to import life saving drugs from other countries.

To become a ham you have to pass a test which is conducted by the Ministry of communication at any of the monitoring stations in each state. There is a written test of one or two hours and a practical test in sending and receiving Morse Code. If you do not wish to learn Morse code you can still become a ham by getting the restricted grade. The different grades of licence and other details are given below.

Grade	Exam fee	licence 2 years	fee 5years	power permitted
Advanced grade	Rs 25	Rs50	Rs125	450W*
Grade I	20	40	100	150
Grade II	10	25	60	50
Restricted grade (VHF only)	10	25	60	10

\*Subject to certain restrictions

You can appear for grade I and grade II together by answering the same question paper. Morse code is at 5 words per minute for grade II and 12 w p m for grade I and advanced grade. (For more details contact the nearest ham or ham club.)

Anyone above 18 years of age and who is a citizen of India can become a ham. Absolutely no educational qualification is prescribed. Subject to certain rules a person between the ages of 12 and 18 can also become a ham. The syllabus for the examination is simple and requires only a minimum knowledge of electricity and electronics. A working knowledge of the rules and regulations is also prescribed. The written test will be followed by practical test in receiving and sending Morse code for 5 minutes each. If you send the application to the Monitoring station you will be required to appear for the test conducted every month. If there are more than 24 candidates in your place, the test can be conducted in your place. You will receive the result in one month and your licence will be issued in about 6 months. You will be allotted a call sign which you have to announce at the beginning and end of talking. The licence of hams in India will begin with the letters VU2 for advanced grade and

(contd. to page 34)



## BEST COMPLIMENTS FROM

*ER. P.T. MOHAN BABU*

# HOTEL VRINDAVAN INN

NEAR

K.S.R.T.C. BUS STAND

**PUNALUR,  
691305.**



# Short wave listening

## First step to Amateur Radio

"SHOW ME YOUR FRIENDS AND I WILL TELL YOU WHAT YOU ARE".

The great man who said these memorable words had no knowledge of ham radio. Hams have friends among all types of people, among scientists, philosophers, theists and atheists, rich and not so rich without any barrier of language or religion. Even if two countries are at war, the hams of the two countries will be friends. It is a language of universal friendship and brotherhood.

Elsewhere in this book you will read about how to become a ham. In this article we tell you how to listen to hams talking on the air and how you can learn a lot about this hobby by hearing the conversation of other hams. Hams are permitted to talk on the short waves only, hence listening to ham talk is called short wave listening. Listening to broadcast (BC) of radio stations is called BC listening and the receiver used for the purpose is called BC receiver. The receiver used by hams is called communication receiver. Broadcasting stations transmit on powers of several thousands of watts whereas hams are permitted to transmit on a maximum of 150 watts. There are many hams who transmit on just 5 watts. Hence the usual BC receiver we use for listening to Broadcast stations will not be sufficiently sensitive to receive ham stations. Communications receivers are designed to be more sensitive to receive ham stations. But communication receivers are not available in India (except as surplus equipment disposed off by army depots) and the cheapest one costs Rs 10,000. But do not be discouraged by the above remarks. Ordinary radios can be made use of for short wave listening with some modifications. You will require a good quality sensitive BC receiver. Now we will tell you how to fix up a good antenna for SW listening.

### THE DIPOLE. (Fig 1)

Hams usually transmit on two frequencies -40 meters (7 Mhz) and 20 meter (14 Mhz). These two frequencies are the most popular ham bands. 40 meters is used for short distance contacts (within a radius of 1000 Kms) and 20 meters for long distance communication. We will start with telling you how to put up an antenna which will enable you to monitor 40 meters. As we said earlier, 40 meter is the frequency used by those who want to talk to their local friends so on 40 meters you can hear a lot of Indians operating. The dipole will help you to monitor them even with your BC receiver.

For a centre-fed dipole antenna take two pieces of copper wire 18 gauge or 14 gauge, 33 feet 4 inches length, enamelled or bare and tie two insulators to the far end of each wire. For insulators you can use plastic sheets, PVC pipes or fuse carriers. Bring the near end of the each wire together and fix them together keeping the distance between them to 2 or 3 inches. Get about 15 mtr of coaxial cable (TV type) and connect the outer braid and inner conductor to each side, near the centre as shown in figure. Hang this dipole about 10 metres above ground using plastic ropes at either end, Bring

the other end of co-axial centre inside the room. Your radio has sockets one for aerial and other for earth. Connect the inner wire of cable to aerial socket and outer to earth socket. If you are using a portable transistor radio which has no A-E socket there is another method Take some thin plastic wire and tie it around the receiver vertically 3 or 4 turns- and connect the two ends of the cable to it.

### LOOP ANTENNA (Fig 2)

Make a square loop using copper wire each side measuring 28.3 inches and bring the two ends to the middle. This can be easily done by fixing four nails on the wall or on a door and looping the wire around the nails. The two ends of the loop are connected to a gang capacitor- one to the ground terminal and other to another terminal of the gang capacitor. Fix a drum to the PVC gang capacitor for easy tuning. Tie 16 feet of 18' gauge copper wire horizontally above the terrace or roof using two insulators at both ends. At one end of this wire, solder one end of a plastic wire and bring other end of the plastic wire inside the house and solder it to the free terminal of the PVC gang capacitor. Place the transistor radio inside of this loop and tune it to any station. Now rotate the drum of the PVC until you hear the station loudest. This loop can be used to tune any station on the short wave band. By trial and error you can find out the best position for the radio where the signal is loudest. No connection to the radio is necessary. You will be able to tune many situations on the 7 and 14 mhz bands.

Tuning in a ham station is a tricky affair and requires lots of patience. The 40 mete band allotted for hams extends from 7.0 to 7.1 mhz which occupies just one millimetres in your radio dial and some times ten stations may be operating in this 1mm space. If your radio has fine tuning it will be easier to tune the stations. Usually hams operate in the morning from 7.00 AM to 9.00 AM and in the evening from 2.00 PM to 5.00 PM. At night the band is very noisy and this makes reception difficult.

### MODES OF TRANSMISSION

Hams communicate with each other mostly in any one of the following modes.

1. Morse code called Continuous wave (CW)
2. Amplitude Modulation (AM)
3. Frequency Modulation (FM)
4. Single Side band (SSB)

Of the above modes amplitude modulation (AM) is the easiest to receive because all broadcasting stations use AM and our radio receivers are designed to receive AM only. There are a number of hams in Kerala and Tamil Nadu who transmit AM and with some patience you will be able to copy them. Very soon you will become familiar with their names, call signs and their daily life. You may even be able to meet some of them in person.

Morse code or telegraph code CW is the next most popular mode. In this mode all letters are formed by a short sound called DOT (Pronounced DI) and a long sound called



Best compliments from

# Classic Marbles

Near P.B. Industries, Adoor, Kerala.

ALL KINDS OF MARBLES & GRANITES WHOLESALE TRADERS

**P.B. INDUSTRIES, ADOOR.**

phone: 422381 (offi:) 422181 (Res:)

## SIGNAL ELECTRONIC CHOKE

MODEL DX-EB 1

Pushing the state of the art in electronic choke design and construction, no one has been able to match the SIGNAL DX - EB 1 in performance, value and reliability.

- ☞ Designed to work in places with very low voltages
- ☞ Power saving circuitry
- ☞ Assembly with industry best components
- ☞ Strict and scientific measures to maintain standards and quality control
- ☞ 16 months warranty
- ☞ (Complete set of instructions is available on request)

A product of

**SIGNAL POWER SYSTEMS**

A- 97, Sreeragam Lane

Thiruvananthapuram 695 010

Phone : (0471) 66507

With best complements VU2TNA SANAL KUMAR



Dash (pronounced as DAH) . For example the letter "A" is dot dash (DI DAH) of course transmitting on CW takes along time to send a message but CW will reach a longer distance and the message can be copied even if there is lot of noise. You can tune your receiver and you may be able to hear morse code but the speed will be too fast for you to copy. Our BC receiver is not made to copy morse code and you will require some arrangement to copy the same. One simple method is to use another receiver. Tune your receiver to a CW station. Place another receiver near it and tune it to about 50 metres -6 mhz. Adjust the second receiver tuning till you get the code clearly. Try to copy a few letters here and there and slowly you will pick up the code . If the two receivers work on battery the result will be better.

Most hams prefer to operate on SSB because it will carry the voice over a longer distance and reception will be better. You can use the same arrangement given above for copying SSB. But the result may not always be good .You can use a variable frequency oscillator or beat frequency oscillator to copy SSB. For this seek the help of ham or ham club. FM is used for walkie only and is not received in BC Receivers. Once you start listening to hams you will learn a lot about hams and ham radio. Next step is to become acquainted with hams.

**QSL CARDS**

After listening to hams talking you can send them QSL Cards . The card should contain details such as call signs of stations working ,time , date, frequency, your receiving and areial set up, You can get the address of hams from call book which will be available with hams. Hams send you their QSL Cards also.

**CODES AND ABBREVIATIONS.**

Hams use a number of codes, abbreviations and phonetic codes , technical words etc. It will take you a long time to learn them by heart ,but by listening to hams you will be able to pick them up easily.

**SWL LICENCE**

Licences are issued for SWL's . For this no test is necessary. By sending the applications form and fees you will get you licence from the Ministry of Communications, New Delhi. To become a Ham, you will have to appear for an examination, conducted by the Monitoring Station in each state, every months, and obtain a licence from the ministry.

So start listening the short waves now and get ready to become a ham.

**MORSE CODE**

*N.G. KOSHY*

Heinrich Hertz in 1887, discovered the electromagnetic or radio waves. Samuel Morse, who was a painter by profession invented the telegraph code- a set of codes which were named after his name and which made long distance communication possible These two epoch making events paved the way for revolutionary changes in communication and electronics which we are witnessing today. It has time and again proved to be the most simple and effective form of long distance communication in the shortest possible time. Even though other forms of communication like telegraphy , and digital technology were developed later , Morse code or CW as it is called still retains its popularity as a simple, reliable method of communication. It would be no exaggeration to say that if Morse had not invented telegraphy , Marconi would not have invented the wireless.

**WHAT IS MORSE CODE?**

As we have alphabets for a language, combinations of which produce words and sentences , Morse code is also a language with alphabets, punctuations and numbers. In Morse Code these are represented by dots and dashes and in sound as dit and dah respectively in various combinations. The dits are short and dashes are longer, to be precise 3 times as long as dit. Although the dits and dashes are distinct , they are not entirely separate from each other. In combination with pauses and spaces they provide sound characteristics, which must be memorised and practiced.

Sending and receiving Morse code is the result of combining mental and physical action in a semiconscious manner. Patience, and perseverance are the fundamental assets towards learning code.

Transmission of Morse code involves the interruption of the Radio waves, using a switch known as a key to produce the sound of a dit or dah as the case may be . In international Morse code , all signalling is accomplished by five basic signalling lengths.

- I. a "DIT" is one unit length.
- II. a "DAH" is three unit length

(Contd..)

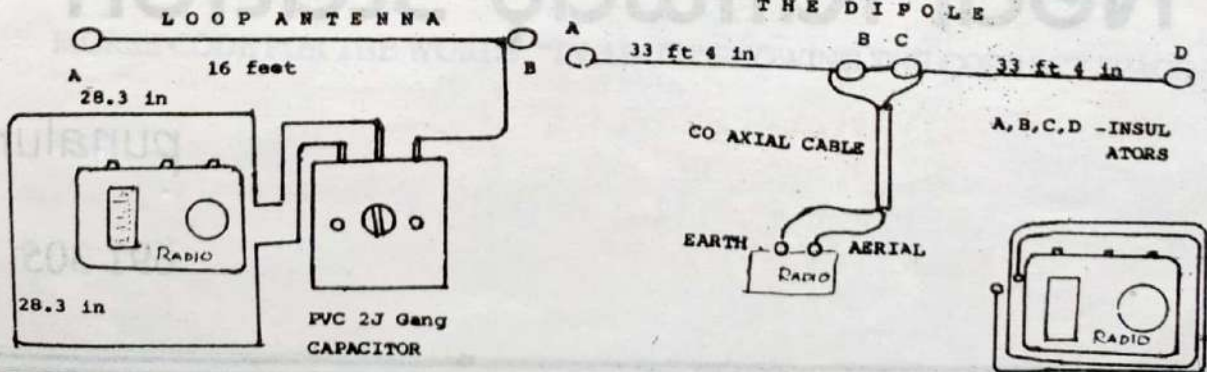



## Best Compliments From

# JAYABHARATHAM MENTAL HEALTH CENTRE

**DR. P. T. RAJAN BABU,**

**Near railway station**

punalur,

691 305



III. character space in a letter one unit

IV. letter space 3 units length

V. Word space 7 units length

A typical grouping of these five lengths are shown in the diagram in code for the words "IN ADUR".

The best method to study code is the "SOUND" method. In this method no thought is given to the characters of the code or letter. The characters are learnt as sounds and are committed to memory.

#### EQUIPMENTS

To learn Morse code, you require a key, and an oscillator. This oscillator known as code practice oscillator or CPO in short is shown in the diagram and has an audio output in a speaker. Primarily there are two ways to learn to copy Morse code. First is by listening to a person sending the code i.e. keying the CPO. Second, by hearing the code on a pre recorded tape. Repeated listening to the code helps to learn the alphabets but no attempt should be made to memorize as dots and dashes. When once you have gained proficiency in copying the code you can proceed to the next step i.e. sending.

#### SENDING

When once you have learnt to receive, it becomes easy to start sending the code. Initially the sending should be slow, till you get control over the movement of your hand but the emphasis should be on timing. For example, if you plan to send the letter "A", it is a combination dit & dah. It should be keyed in such a way that it sounds like didah and not as dit

dah, in which it sounds like E T. Similarly spacing between letters and words is important. Another important aspect in sending is positioning yourself correctly. You should sit comfortably, with table of correct height - 30". It should be flat with sufficient space to rest the forearm.

The key should be firmly fixed to the table. The rocking movements should be at the wrist. The thumb and forefinger holding the knob should be relaxed.

When you are sure about correct sending technique you can increase the speed of sending. Incidentally, you can record your sending on a tape and replay the same- you will know your own standard and help you to improve your performance. Important consideration in developing proper key manipulation is the adjustment of key spring, tension and contact spacing.

Remember- you should never send at a speed at which you cannot copy. If you can copy at ten words per minute your sending should be at the same speed. Only patience and perseverance making you perfect.

For all your requirements to learn Morse.

#### **Contact :**

ADUR AMATEUR RADIO CLUB,  
MUKALETHU MATOM,  
ADUR 691 523 ,  
Phone : 0473 - 422358.

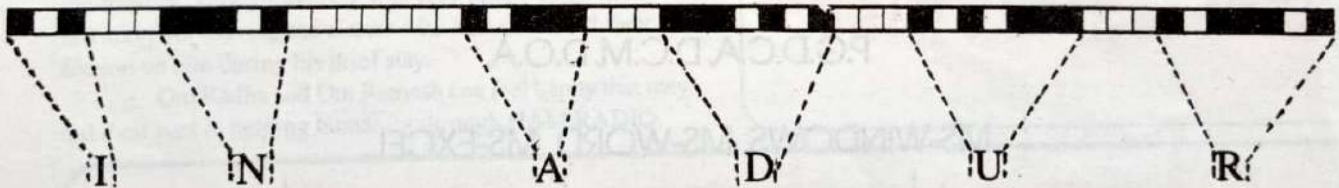

MORSE CODE FOR THE WORDS "IN ADUR" SHOWING THE CORRECT SPACING



**With Best Compliments From**

# VISWABHARATHI SCHOOL OF NURSING

**ADUR**

**INDIRA DAS**

**☎: 0473 - 422842**

**DIRECTOR**

# HI-TECH COMPUTERS

NEAR K.S.R.T.C. STAND

**ADUR**

PG.D.C.A,D.C.M,D.O.A,

MS-WINDOWS, MS-WORD, MS-EXCEL,

FOXPRO, COBOL, C, C++, ORACLE, POWER BUILDER,

FORMS @4.0, AUTOCAD, WORD PERFECT,

**CHOICE OF STUDIOUS STUDENTS**



## HAM ANECDOTE

It was a fine sunny morning in Thalassery on that day, Kotayi Rajeev, a milk vendor was on his morning rounds when he noticed a boy lying on the floor of the bus stand. The boy appeared to be about 7 years old and was shivering with fever. It seemed that the boy had been suffering for quite sometime and had no food to sustain him and no medicine to cure his illness. Rajeev took pity on him and had him admitted to the local Govt. Hospital. Under the treatment of the doctors and sisters he regained his health and was able to talk. But since he could speak only Telugu sisters had a hard time in finding all the details about him. They could gather that his name was Seetharam and his native village was Noojapet. His father was Suryacandra and step mother was taking care of him. The local Malayalam dailies Manorama, Mathrubhumi published news about the boy, which was read by Om Radhakrishnan VU 2 RDH who is an advocate in Payyanrur and needs no introduction to hams. Om Radhakrishnan contacted Om Socrates VU 2 NJS, Ramesh, VU 2 RDM and also sent a tape recording of the boy's talk to find out all information about him.

The boy Seetharam was studying in first standard in a primary school in Kothahalli in Nuchiveedu which was the correct name of his village. The father was a drunkard and the mother made her living by loading mangoes in lorries and supported her family which consisted of six brothers and sisters. The boy was kidnapped by some persons and abandoned at Vijayavada for reasons not known. The boy got into a train and got down at Thalassery and was stranded there where got ill. Ramesh tried to contact the local police who showed little interest in the case. Hence the news was published in the Telugu dailies of the locality. The news reached the father and mother who managed to make enough money to come to Thalassery. Ramesh told Radha that the father will be coming to pick up his boy. The boy's joy knew no bounds when he met his father accompanied by a teacher of the locality. Though the boy was very happy to go home he felt sorry for leaving the sisters who had showered their affection on him during his brief stay.

Om Radha and Om Ramesh can feel happy that they did their part in helping humanity through HAM RADIO.

## IRF 830 LINEAR

P.M.YASEEN VU3 PMY

Om Yaseen, VU 3 PMY needs no introduction to Hams in Kerala. Within a short time he has become one of the most popular hams loved by all. He is always ready to take part in any ham activity anywhere in Kerala and always ready to help other hams. He has done a lot of experiments in using IRF 830 linear and the circuit given has been found to be most simple and effective. Yaseen has given the following directions for assembling the circuit. IRF 830 should be fixed close to the PCB. Use metal gang variable capacitor in the final tank circuit. All capacitors are 250 V polyester. Use a heat sink with multiple fins at least 12 square inches. Use thin mica separator and silicon heat sink compound to mount the IRF. Adjust 10 K preset for no signal current 10 to 30 ma.

### COIL DATA

- L1 8 turns primary and 8 turns secondary bifilar wound on 1.4 X 1.4 cms TV Balun core.
- L2 6 turns through TV Balun core
- L3 12 turns with centre tap for antenna 18 SWG on 1-3/4 inch diameter coil former.  
Connect antenna load while testing.

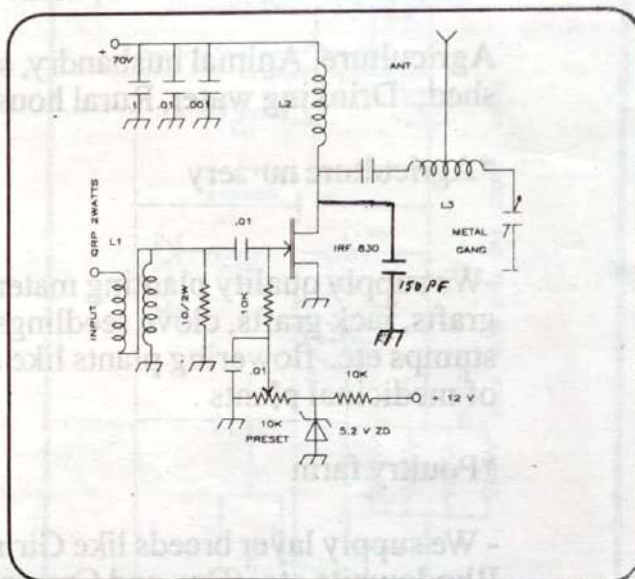



# PASSS

## PAZHAKULAM SOCIAL SERVICE SOCIETY



PAZHAKULAM P.O.  
ADUR- 691527  
PATHANAMTHITTA  
KERALA

Phone : (0473) 422262, 424372

Fax : 0091- 473 - 423491

\* Secular Non Governmental Organisation

\*Socio- Economic Development of Weaker section; through

Agriculture, Animal husbandry, smokeless chulha, training land and water shed, Drinking water, Rural housing and sanitation.

\*Agriculture nursery

-We supply quality planting materials like coconut seedlings, mango grafts, jack grafts, clove seedlings, nutmag seedlings, all spices teak stumps etc.-flowering plants like anthurium, Orchids, roses etc.- All types of medicinal plants .

\*Poultry farm

- We supply layer breeds like Giriraja, Austolorpe, Austowhite, Rhodowhite etc. (Day and Grown up)-Also supply cob broilers (Day old and grown up)

*President,*  
PASSS



# SOME VFO DESIGN STANDARDS

O M DEVAN VU 2 RMZ

# Power supply for Handheld Rigs

G. Pradeep kumar

Most hams assembled a VFO for 7 Mhz. Some may try on 3.5 Mhz and use a doubler for 7Mhz. However if you wish to make a VFO for a SSB project you may require VFO for 2 Mhz, 5Mhz, 2.5 Mhz etc. This article based on a design by Om Devan VU 2 RMZ will help you to design a VFO for any of these frequencies. The tuned circuit is given in Fig. 1. Anyone of the transistors BFW 10, BFW 11, 3 N 200, BF 966 , BF 960 can be used without making any changes. There will be downward shift if bipolar capacitors are used . The following table will give the component values for 2, 3.5, 5 and 7MHZ. For C1 one section of 2 J gang capacitor is used . You can also use one section of a metal gang capacitor (used in old valve receivers and still available in some shops). If you remove all the metal rotor plates except one, then C2 & C3 need not be used. Only good quality styroflex capacitor should be used.

Frequency	L1	L2	C1C2	C3	C4	C5	C6	C7	C8	C9,10
1.9-2.00	10	800	100	3.8	33	33	47	11	1000	2000
3.5-3.55	05	450	10	9.4	10	47	22	14	560	1000
5.0-5.35	04	300	47		33	33	3.8	380	460	
7.0-7.10	03	220	10		33	22	17	200	330	

Values of L1 & L 2 are given in microhenries .Capacitance values are given in picofarads. C3 and C7 are button trimmers adjusted to the correct value. Junction capacitance

of 1N 4148 has been ignored in the calculation.

Approximate number of turns for winding L1

Length of winding approximately half inch.

Frequency	No of turns when diameter of former is;	
	1/2 inch	1/4 inch
1.9 - 2.00	34	62
3.5 - 3.55	24	44
5.0 - 5.35	21	39
7.0 - 7.1	18	34

For iron core reduce the number of turns by half.

Use suitable gauge wire so that length of winding is 1/2 inch.

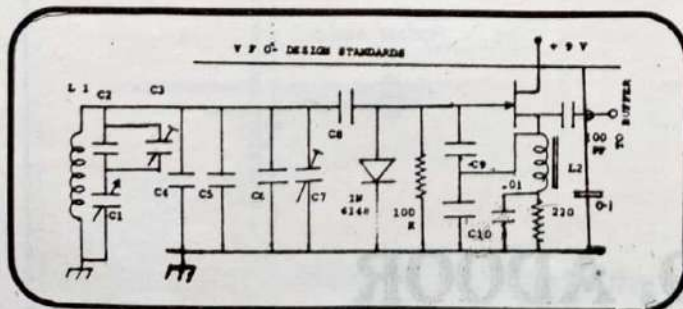

An inexpensive circuit for 12 volt regulated power supply with output current supplying capacity up to 5 amperes is shown here. This power supply is specially designed for using with two metre with linear, CB handheld, portable QRP's etc.

Use of 5 ampere rated diodes are recommended. Two 3 amp rated diodes can be paralleled also. The circuit has facility of overload current limiting . Medium power transistors (PNP) TIP 32 and four one ohm resistors in parallel are used for this purpose. If you require 13.4 volts output supply just connect two silicon diodes in series between pin 2 and ground of regulator IC. Then output voltage will be between 13.2 and 13.4 volts.

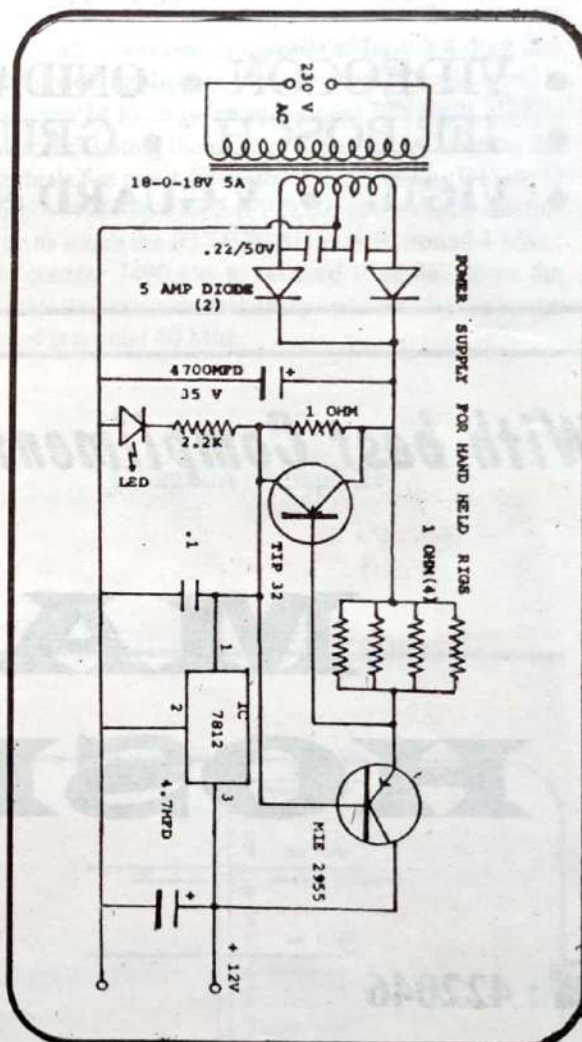



WITH BEST COMPLIMENTS FROM

# VIEW POINT ELECTRONICS

M.C. ROAD, ADOOR



ENTERTAINMENT ELECTRONICS



HOME APPLIANCES



KITCHEN WARE

*AUTHORISED DEALER FOR:*

- VIDEOCON • ONIDA • SONY • PANASONIC
- IFB BOSCH • GRUNDIG • AKAI • ALLWYN
- VIGIL • V GUARD etc.

*With best Compliments from*

# MARIA HOSPITAL

 : 422046

K. P. ROAD, ADOOR



## SIMPLE FIVE ELEMENT BEAM FOR TWO METRES

Dr. K. Raju VU2GOK

This two metre beam antenna is so simple that anyone with a little bit of experience can construct it in a short time. Usually beam antennas require an insulated boom for supporting the elements. However in this design, we are using aluminium boom itself to give more strength to the antenna.

### REQUIREMENTS

Aluminium square rod 1" x 1" - 6 feet long.

Elements-Aluminium rods 1/4" diameter tubes approximately 6 feet.

1. Reflector 40"
2. Driven element 38 1/2"
3. Directors 36 1/2", 36 1/4", 36"
4. 10" aluminium tube for gamma match
5. Bracket as shown
6. Co-axial connector socket female
7. RG8 cable

The aluminium rods are cut to their size. 1/4" holes are drilled through the boom on either side at intervals as shown. The cut aluminium rods are pushed through the holes and fixed with a screw in the centre over the boom.

An aluminium flat strip 1" x 5" is bent into an "L" shape. One arm of L is fixed on the boom just below the driven element with screws. A HF connector is fixed on the other limb of the bracket. The 1/4" aluminium tube 10" long is taken and fixed to the bracket side of the driven element with a bracket as shown. About 10" to 11" of RG8 co-axial cable is taken and is stripped of its outer braid. The inner core with its plastic sheath is passed into the aluminium tube. The inner wire of this cable is soldered to the centre pin of the HF Connector, which is fixed on the bracket (see diagram)

### GAMMA MATCHING

The inner conductor of the RG8 cable and the aluminium tube in which it is placed act as a capacitor for the gamma match. Sliding the aluminium tube will vary this capacitance and will facilitate correct matching to get SWR of one. The inner conductor is then fixed in this position.

NOTE: The number of directors can be increased or decreased to vary the gain.

## FREQUENCY COUNTER

Dr. N. Vasudevan Nair Msc. Ph.D (IIT/K) VU2 VDN

As per amateur radio regulations every amateur station should have a frequency counter to monitor the frequency of emission. Even a transceiver using PLL gives the frequency for which the instruction given to the circuit.

Here a frequency counter using crystal oscillator for precise timing and the new CMOS IC 74C926 having facilities for reset, latch and hold is described. The basic oscillator is of 1Mhz and by using decade counter IC 7490 it is divided to produce 1 Hz. square pulses. The input to the counter is converted to a square wave by the squaring circuit using IC 7400 and is passed through a two input NAND gate the 2nd input terminal of which is given the 1 Hz. pulse. Hence, the converted frequency will be in Hz. A noval locking circuit for opening the gate for exactly 1 sec. is developed by the author using the master - slave Flip Flop IC 7473. A monostable IC 74121 is used to produce pulses for resetting the counter with a time period of 2.4 seconds Two counter ICs 74C926 are connected in cascade to have a 8 digit display. The input is applied to pin 12 of this IC and output is taken from pin 14 to be given to the next IC's input. While the counter is counting the display is latched by keeping the latch terminals 5 at ground potential by connecting it to the Q terminal (pin 9) of Flip-Flop2-(FF2). Since the maximum frequency up to which the IC 74C926 counts is around 4 Mhz., a decade counter 7490 has to be used to scale down the input. By this the maximum frequency up to which the counter can be used is around 40 Mhz.

(Diagram on page 21)

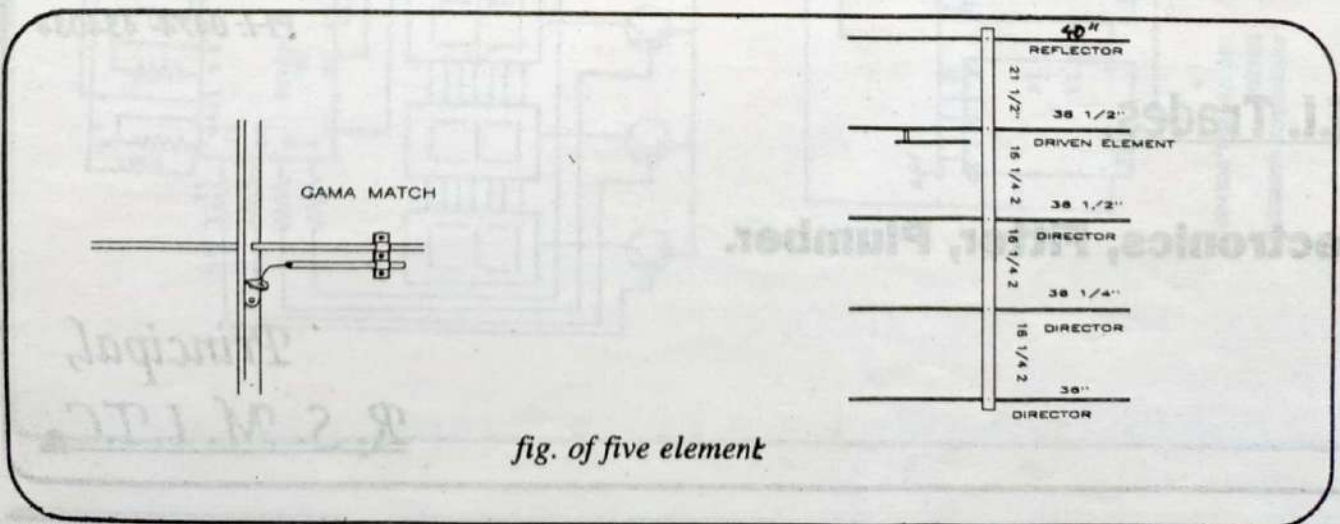

fig. of five element



# 1st ANNIVERSARY GIFT SCHEME

Now at



The BRIGADE

5001

worth

gifts

**Kottayam, Thiruvalla**

SHOES, SANDALS, LEATHER GOODS, TIES ETC.

With best compliments from:

**R. SANKAR MEMORIAL I.T.C.**

**Estd: 1980**

**MUSLIM STREET  
KOTTARAKKARA,  
PIN-691506  
PH: 0474- 454034**

I.T.I. Trades,

**Electronics, Fitter, Plumber.**

*Principal,*  
**R. S. M. I.T.C.**



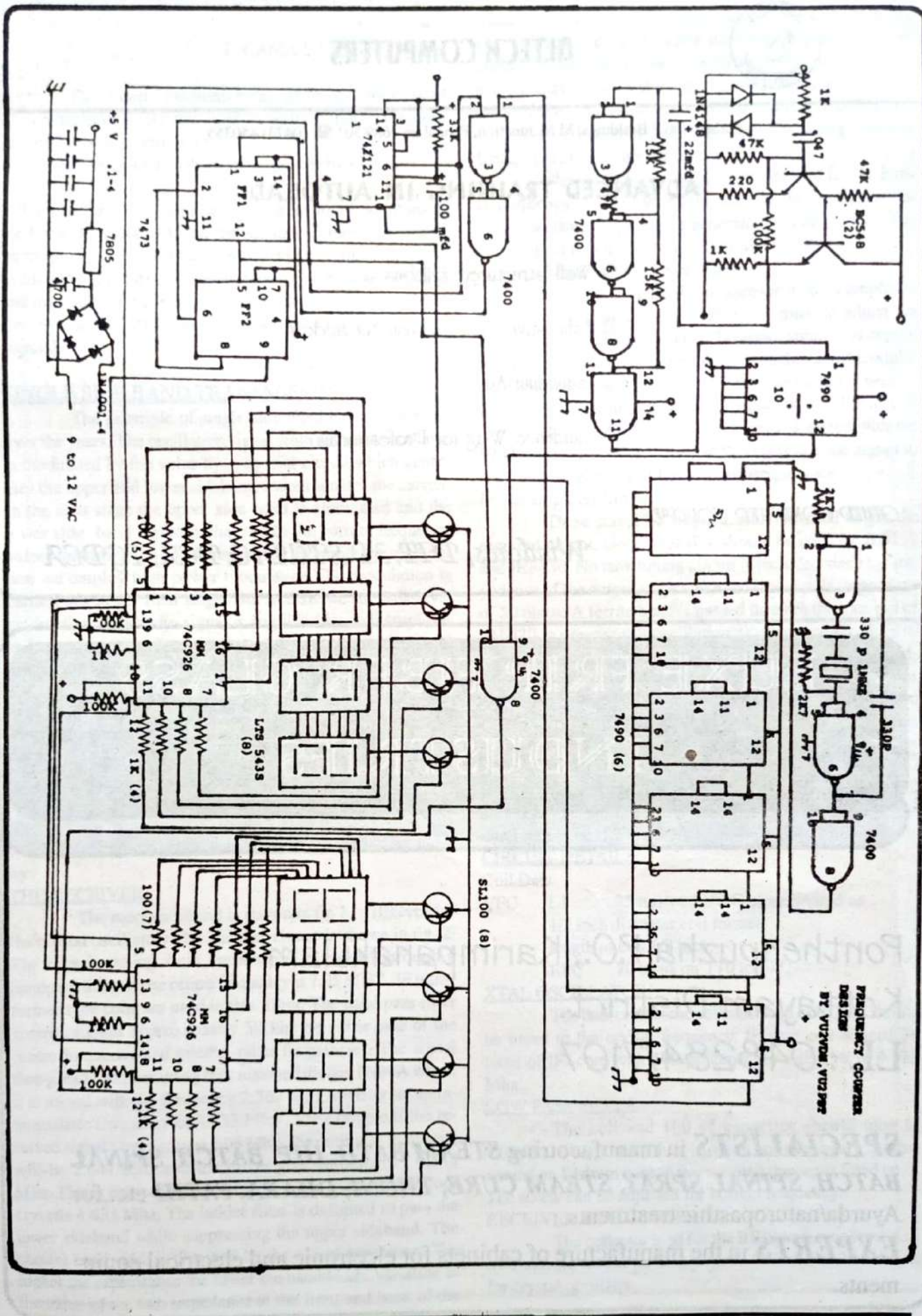





## ALTECH COMPUTERS

Puthenvilayil Buildings, M.M.Junction, Pandalam - 689 501 ☎ (0473) 450355

### ADVANCED TRAINING IN AUTOCAD

- ☞ Well-structured syllabus
- ☞ Exhaustive Coverage on 3D Models
- ☞ Individual Att.
- ☞ Guidance Wing for Professionals

*OTHER COMPUTER COURSES*

*Windows, DTP, 3D STUDIO, DCA, PGDCA*

## LUXE FRIP FIBER GLASS INDUSTRIES

Ponthenpuzha P.O., Karimpanakulam  
Kottayam District.  
LL : 048284/7107

**SPECIALISTS** in manufacotring **STEAM BATH, HIP BATCH, SPINAL BATCH, SPINAL SPRAY, STEAM CURE, THONI, DHARA, PATHI** etc.,for Ayurda/naturopasthic treatments.

**EXPERTS** in the manufacture of cabinets for electronic and electrical equipments.



# 7 MHz TRANSCEIVER

P. RAMA SWAMY VU2 PRI

This 7 mhz SSB transceiver can be built for the cost of a commercial SSB filter. With 50 watts output it compares favourably with a commercial rig. It uses components which are available in VU2 land

Till a few years ago building a SSB transmitter was considered a challenging task and the number of hams who came on the air in SSB could be counted on ones fingers. With the availability of good components, development of new designs and ingenuity of the Indian ham, several hams have come on the air with SSB rigs which compare favourably with commercial ones.

## SINGLE SIDE BAND TRANSMISSION

The principle of single side band has not changed over the years. The oscillation signal from a crystal oscillator is modulated by the voice by a special circuit which generates the upper and lower sideband and eliminates the carrier. In the next stage the upper side band is eliminated and the lower side band signal is changed to the correct frequency before amplification and transmission. In amplitude modulation we employ high power modulation-The modulation is carried out in the final stage. But in SSB we use low level modulation. The audio signal is amplified by a preamplifier and mixed with the signal from crystal oscillator in a balanced modulator which suppresses the carrier and produces the two side bands. In the next stage one of the sidebands is suppressed. There are two methods of suppressing either of the side bands-1 (Phase shift method which while cheap is comparatively less efficient, 2) filter method. A crystal filter for SSB is costly and costs about Rs 1000. The chief advantage of the present design is that for the crystal oscillator and the filter we are using the TV colour signal frequency crystals which are cheap and easily available without sacrificing quality.

## THE RECEIVER

The receiver circuit is shown in fig 1. (Except for the crystal oscillator) The xtal osc. circuit is shown in fig. 2. The signal coming from the antenna is passed through a bandpass filter whose centre frequency is 7.05 MHz. IF transformer type coils are used in this filter. The band pass filter accepts signals approximately 50 khz on either side of the centre frequency and rejects other frequencies. The signal then goes to a mixer using four matched diodes 1N34A where it is mixed with the frequency 2.567 Mhz to generate an intermediate frequency of 4.433 Mhz. For example if the received signal's frequency is 7.08 Mhz, the oscillator frequency will be 2.647 Mhz and the mixer give an output of 4.433 Mhz. This is passed through a ladder filter consisting of four crystals 4.433 Mhz. The ladder filter is designed to pass the lower sideband while suppressing the upper sideband. The correct bandwidth is obtained by the use of capacitors. The higher the capacitance the lower the bandwidth. Variation in the value of the two impedance at the front and back of the

ladder filter will also affect the band width. Some trial and error with various of the capacitors will have to be undertaken to obtain the correct bandwidth. This is because all crystals may not have the same resonant frequency. Even a difference of 50 Hz will alter the bandwidth. The IF signal is then amplified in a two stage amplifier using 2 nos of BF194B. The coils are wound on IF cores.

The next stage is the product detector in which the IF frequency of 4.433 Mhz is mixed with the crystal oscillator of the same frequency to generate the audio signal. The audio signal is amplified by BC147 and LM380.

Transmitter- exciter (fig 3)

Sound falling on the condenser mike is amplified by IC 741. A preset is included in the mike to adjust the voltage to the mike to 5 volts. The audio signal and crystal oscillator frequency are introduced to the balanced modulator using four matched diodes. This same circuit is used in the receiver section to generate IF signal of 4.433 Mhz.

The 4.433 Mhz lower sideband is mixed with the VFO signal of 2.567 to 2.667 Mhz to produce the signal in the 7 Mhz to eliminate all unwanted frequencies.

Power amplifier (fig 4)

Three stages of amplification are used to get the required output. Good heat sink should be used for BD139 and IRF830. No tank tuning circuit is included since the impedance of the output stage will match the dipole impedance of 50 ohms. A ferrite bead is passed through the gate pin of IRF830 to prevent self oscillation as otherwise the IRF830 will destroy itself The 10k present in the gate circuit is adjusted to get no signal current of about 30 to 40 ma. For IRF830 use a heat sink which is at least 12 sq. inches and use silicon compound for good heat transfer. A 150 capacitor is connected from the drain of IRF830 to ground to suppress harmonic frequencies.

The power transformer has two secondaries - 40V2 amp and 15V lamp. IC regulator 7812 is used to get regulated supply of 12V.

## CIRCUIT DETAILS

Coil Data

VFO L1 25 turns 33 SWG close wound on  
1/2 inch diameter coil former,  
length of coil 1/2 inch.  
RFC 20 turns on T10 toroid.

## XTAL OSCILLATOR.

The tank coil for the collector load of BC548 should be tuned to the crystal frequency. IF type coil is used 36 turns of IF core with 100 pr. capacitor will tune to 4.433 Mhz.

## LOW PASS FILTER

The coil and 100 pf capacitor should tune to 7.05mhz. The primary has 15 turns and secondary 5 turns wound on IF drum core. After winding the cap is fitted on it. The screw can be adjusted for correct frequency.

## RECEIVER IF AMPLIFIER

The collector load for the BF194 are tuned to 4.433 Mhz and are wound on IF type core. Coil data is the same as for crystal oscillator.



*With best compliments from*

- On the Roads/abroad-beside Indian
- High Fuel Efficiency
- Carry any load - any road
- After - Scale Network

**KAL**

**"Three Wheelers you Roll-  
- We Export Abroad"**

*Manufactures of widest range of Diesel and Petrol Three Wheelers.*

**KERALA AUTOMOBILES LIMITED**

THIRUVANANTHAPURAM- 695 123.

PHONE : (0471) 222512 to 2225 15 Fax : (0471) 222640 TLX ; 0435 - 6258











BEST COMPLIMENTS TO *HAM EXPO '96*

# PAVITHRA KUMAR & ASSOCIATES

Accountants & Tax consultants,  
Main Road,  
Kayamkulam- 690 502, ☎ - 443607.

*we undertake*

-  Preparation of Books of Accounts.
-  KGST & CST Regn:
-  Project Report for Loans.
-  Practical Training in Accounting.

Mg:partner.  
Pavithran - SWL.

BEST COMPLIMENTS FROM

# DTDC

## Courier Service

*(Near Swathy Saree Show room)*

Adur.



# HOMEBREW RECEIVER FOR 40 MTR

OM DEVAN - VU2 RMZ

The circuit described below has several features not found in the designs so far published in ham journals. The frontend RF amplifier and bandpass filter ensure good selectivity and sensitivity and also image frequency rejection. A separate transistor for the oscillator gives isolation between the oscillator circuit and antenna input circuit and helps to avoid oscillator pulling. An IC MC 1596 has been used for the first mixer circuit. Two ceramic IF reduce the bandwidth & noise and reduces interference from adjacent stations. Three stages of IF amplifiers are employed for better gain. Since only easily available bipolar transistors are used the cost is quite low. The circuit also incorporates a signal strength meter which however can be omitted if not necessary. BFO 10 is used for beat frequency oscillator for better stability. The frequency can be varied by varying the potential to 1N 4148 diode in reverse mode which acts as a varicap diode in the tuned circuit of BFO.

For receiving CW & SSB, BF 966 is used as a product detector. Standard IF transformers are used. A potentiometer in the S-meter circuit is used to adjust AVC bias. One section of 2J variable capacitor is used for tuning stations

The block diagram of the RX will help you to understand the circuit better. The bandpass filter permits 7 to 7.1 MHz signals to reach the RF amplifier. Oscillator frequency is 6.545 to 6.645 MHz to generate intermediate frequency of 455 KHz. Two ceramic filters are used to reduce the bandwidth. There are 3 stages of IF amplification. The rest of the circuit is conventional. The power supply is regulated voltage of 12 volt 1 ampere regulated by IC 7812. PTT jack is included in the power supply to RF amplifier. The oscillator voltage is regulated by 5.1 volt zener diode.

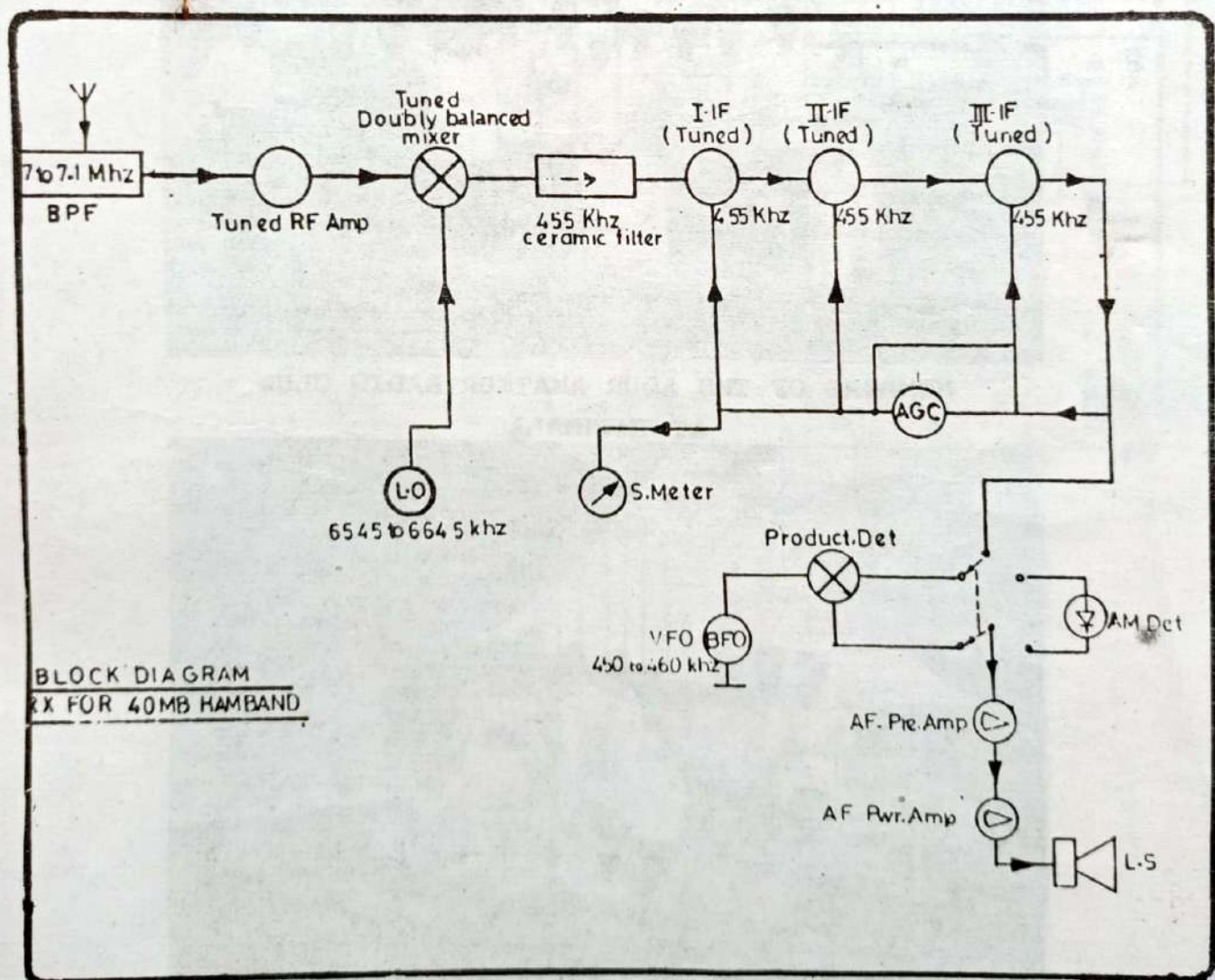





**FIELD DAY STATION AT THENMALA  
ERECTING THE ANTENNA**



**MEMBERS OF THE ADUR AMATEUR RADIO CLUB  
AT THENMALA**









(Contd: from page 7)

grade I . VU3 is for grade II & restricted grade. The last three letters will be different for each ham.

For more information about ham radio , and its examination write to : L.V.Sharma VU2 LV, Mukalethu

Matom , Adur 691 523. . The Adur club is regularly conducting classes on Sundays.

73 and good bye.

P THAJUDEEN VU3 TJN.

With best compliments from:-

*When Design is the sign*

**'S' Graphix**

NNASS BUILDING, CENTRAL ADUR

☎ : 422417

Creative Designers Advertisers, Offset and Screen Printers

**അശ്സർ**

അശ്സർ, അസിഡിറ്റി തുടങ്ങിയ ഉദരരോഗങ്ങൾക്ക്  
പ്രകൃതിദത്ത പ്രതിവിധി

**അടുർ അശ്സർ ക്ലിനിക്**

നാസ് ബിൽഡിംഗ്സ്, സെൻട്രൽ അടുർ.

ഫോൺ : 422417







**WE HAVE A FEW WORDS  
FOR PEOPLE WHO DEMAND HIGH  
PERFORMANCE  
AND EXPECT TO PAY  
PEANUTS FOR IT**

*COMPLETE RANGE OF DELTA PERSONAL COMPUTERS UP TO PENTIUM  
AT STREET PRICE FROM*

**MICROLOGIC**  
ELECTRONICS (P) LTD.

*CHIRAYATHU BUILDING , YMCA JUNCTION, THIRUVALLA, KERALA -689101 PH : 0473 - 625585*

- ◆ PERSONAL COMPUTERS ◆ PERIPHERAL ◆ SOFTWARE DEVELOPMENT
- ◆ NETWORKING ◆ ANNUAL MAINTENANCE CONTRACTS ◆ SERVICING
- ◆ HARDWARE MAINTENANCE TRAINING FOR ENGINEERS AND NON ENGINEERS ◆

*DELTA BRAND PC'S ARE MANUFACTURED BY*

**DAN COMPUTER CO. (P) LTD. THIRUVALLA.**



# 7 MHz VFO WITH MEMORY

AJAYA KUMAR & PRAVEEN

This circuit can store up to 9 frequencies which can be recalled by pushing a switch and it can also be used as a regular VFO. There are two sections -the usual VFO circuit and a programmer for recalling frequencies.

The VFO circuit uses a varactor diode for tuning, MV2109. 11 turns wire wound on 1/2 inch diameter (13 cms) air core coil is the tuning coil. The rest of the circuit is conventional.

For tuning, a varicap diode is used and tuning is accomplished by varying the voltage to the varicap diode. When the voltage varies the capacitance varies and oscillator frequency varies. It is possible to cover the ham band 7.0 to 7.1 Mhz with this diode. Decade driver IC CD4017 is used in the programmer circuit.

When a positive pulse is given to pin 14 (by pressing the push switch) pin no 3 goes high and stays high till the next pulse. By pressing the switch a second time pin 3 goes low and pin 2 goes high. During the next pulse pin 2 goes low and pin 4 goes high. Each successive pressing of the switch make pins 7,10,1,5,6,9,11 go high in that order. When the switch is pressed for the first time pin 3 goes high. A 100K linear 10 turns potentiometer is used to vary the voltage to

vary cap diode. Hence tuning of the full band is done by varying this potentiometer. When pressed twice pin 2 goes high. The preset in the circuit is adjusted to bring the frequency to 7.09 Mhz. Hence by pressing the switch twice we can recall the frequency of 7.09. During the next push pin 4 goes high and preset is adjusted to bring the frequency 7.08 Mhz. In the same way 7 more frequency can be stored and recalled by pushes on the switch (Fig 1).

The circuit has been tested and found to work satisfactorily.

If no frequency counter is available for finding the frequency it may not be possible to know which is the frequency being recalled. This problem can be solved connecting a LED in series with 1K resistor from each pin (Fig2)

In practice it was found that sometimes pressing the push switch may cause the circuit to trigger twice. This problem was solved by using a 555IC to trigger the circuit. A resistor of 100k and a capacitor 10 mfd will produce a pulse every second which will send a pulse to pin 14 every second. This was found to be more convenient. Touching the plate or pressing the switch in base circuit of BC547 caused the IC to trigger pin 14.

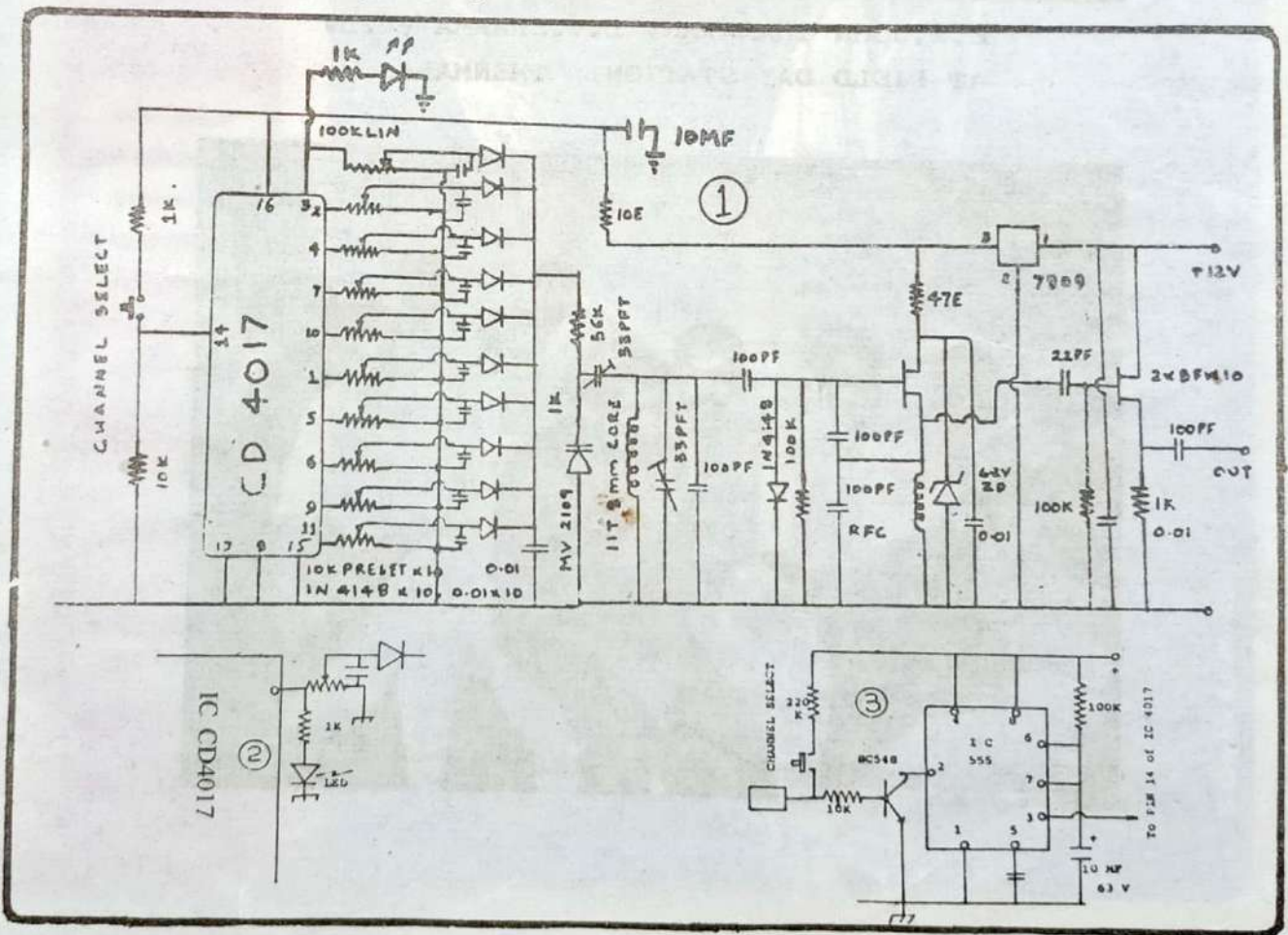



## ADUR AMATEUR RADIO CLUB

## FIELD DAY ACTIVITIES



E.K. JOHN THARAKAN, L.V. SHARMA VU2LV  
AT FIELD DAY STATION, THENMALA







BEST COMPLIMENTS FROM

**BUY GOOD FEEL GOOD**

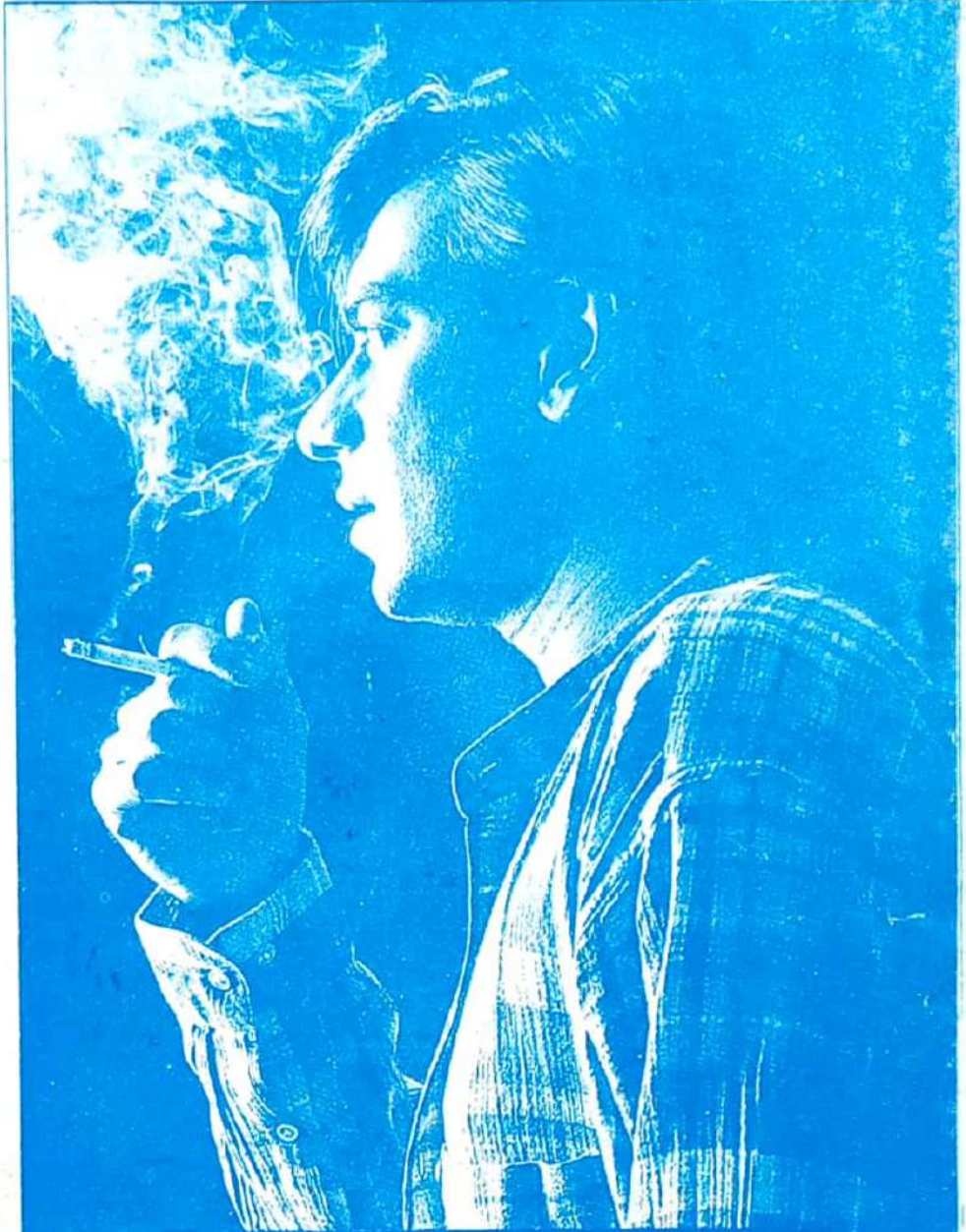

**V.J.P.**  
TEXTILES  
CENTRAL ADOOR  
PHONE: 422472

S' Graphics Adr Ph: 422417



*"A Super Electronic Security: Throughout Your Sleep"*

## Security Alarm

SECURITY SYSTEMS FOR  
INSTITUTIONS, HOMES & MOTOR VEHICLES



1  
Year Warranty



**TECHNO SYSTEMS & CONTROLS**  
**ADUR 691 523**

**PH:(0473)-423003,423010, 422699**  
**PATHANAMTHITTA Dist.**

*our sister concern:*

**THE SCHOOL OF COMPUTERS I. T. C.**

**ADDOOR - 691 523**

**PATHANAMTHITTA (Dist.)**

**Ph: (0473)-423003,423010, 422699**

**Study Computer courses from a computer  
professional with Govt: Accreditation**

*Our courses...*

DP&CS (N.C.V.T.), P. G. D. C. A, D. C. A, A. D. C. A, D. O. E, D. C. M, etc.

*Advanced courses*

**AutoCAD, Rel - 12 &13, M.S. Office,  
3D Studio, Animation, Foxpro, C+ +, Visual Basic etc.**

Printed & Published by the convenor HAM EXPO '96 for AARC mukelethu matom, Adur -691523